

Information for installers

Daikin Altherma Low Temperature monobloc heat pump

The natural choice

Why choose Daikin?

Daikin is the world leader when it comes to air conditioning and heating. Our broad experience, technical innovation and responsive customer service help you to meet all of your objectives. In addition, thanks to our constant innovation in comfort, energy efficiency, control and reliability, we define the benchmarks for quality within the industry. Characteristics your customers are bound to appreciate.



Seasonal efficiency, smart use of energy

The EU wants to inform people about the amount of energy that products consume, and will ban inefficient products from the market. Seasonally-efficient units are optimised to be energy efficient for the average conditions users can expect over an entire heating and cooling season.

From September 2015, all heating systems, including those using heat pumps, will receive an energy label to help customers make the most energy-efficient choice.

System efficiency*:

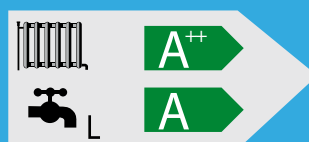

* EHVH04S18CB3V + ERLQ004CV3



Why choose Daikin Altherma LT monobloc?

The Daikin Altherma low temperature (LT) monobloc is the new, all-in-one heat pump developed specifically for Europe. It combines the best of today's heat pump technology with easy installation, making it the perfect fit, especially in homes where space is limited.

✓ Comfort

Your customers demand optimum comfort year round for their space heating and domestic hot water needs. The Daikin Altherma LT monobloc guarantees this as only Daikin can.

✓ Control

Our specially developed and proven control system with its new user interface makes the Daikin Altherma LT monobloc intuitive and easy to control. This means easy commissioning for you, while your customers are totally in charge of their comfort and costs.

✓ Energy Efficiency

The Daikin Altherma LT monobloc 5kW unit is highly efficient, outperforming COP levels and with a flat-line capacity up to -7°C. Its wide modulation increases efficiency further and guarantees low running costs. This means that the monobloc meets all new build legislation in Europe and has an A++ energy label.

✓ Reliability

Reliability is essential to any new heating system, both for you and your customers. Daikin technology, designed and manufactured to the highest standards, has proved to be the ultimate in reliability. Based on years of development and experience, and manufactured to exact tolerances, our technology will deliver years of trouble-free operation.

What is heat pump technology?

Heat pumps extract heat from the outside air, even in cold weather. They use an electrically powered compressor and are extremely effective at heating a flat or house. Silent and discreet, Daikin heat pumps use state-of-the-art technology to keep your energy bills as

low as possible. With a Daikin heat pump, 75% of the energy used to heat your home comes from the outside air, a free and infinitely renewable resource! For cooling, the system is reversed, extracting heat from the indoor air.

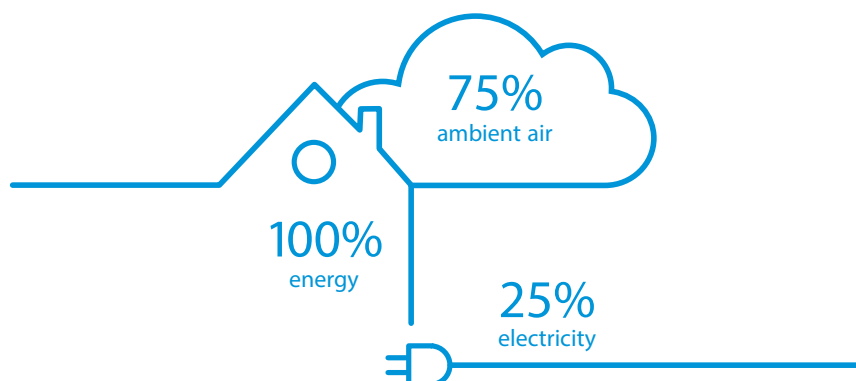

A natural fit for your business

With only water connections to the outdoor unit and a limited amount of wiring, the Daikin Altherma LT monobloc promises fuss-free installation, whether you are new to renewables or are already an expert.

The new Daikin Altherma LT monobloc is available in 5kW and 7kW models, making it the natural choice for homes where space is at a premium. The only indoor element is a wiring centre, so the impact on interiors is minimal. The outdoor unit is small enough to allow it to be installed almost anywhere, under a window sill, or in the smallest of gardens. So it is a natural fit for new builds as well as for renovation projects.

Best of all, it works straight out of the box with no hidden extras and is quick to commission. It's efficient and reliable, all year round, with frost protection features and a user-friendly controller to minimise the call backs. This means that you can complete more projects in less time and grow your business with Daikin. Easy to sell, install, set up and service, it's the heat pump that fits everywhere.

Three key advantages

1. SCOP up to 4.39 with tseasonal space heating efficiencies up to 172%
2. Easy installation straight out of the box, with no refrigeration handling
3. Reliable operation with near constant capacity at outdoor temperatures as low as -25°C

Other benefits

- › Available in 5kW and 7kW models
- › Smallest installed volume on the market
- › Delivers water flow temperatures up to 55°C
- › Frost protection features for winter peace of mind
- › Quiet, compact outdoor unit
- › Quick to commission, user-friendly controller

A heat pump makes green projects a breeze...

A heat pump is a practical answer for house builders and property developers who are looking for low carbon solutions to reduce householders' energy bills. And it is equally attractive as a green heating solution for full renovation projects where it can deliver the ultimate in comfort, efficiency and control.

A Daikin Altherma heat pump uses heat from the outside air to warm a home's central heating and hot water system. Even when it's freezing outside, a Daikin Altherma heat pump can extract heat from the air. For every kilowatt of electricity the heat pump uses, it generates about 3-4 kilowatts of renewable heat from the air. Over the course of a year, it's about 300% efficient.

Trust us, this is the future of heating.



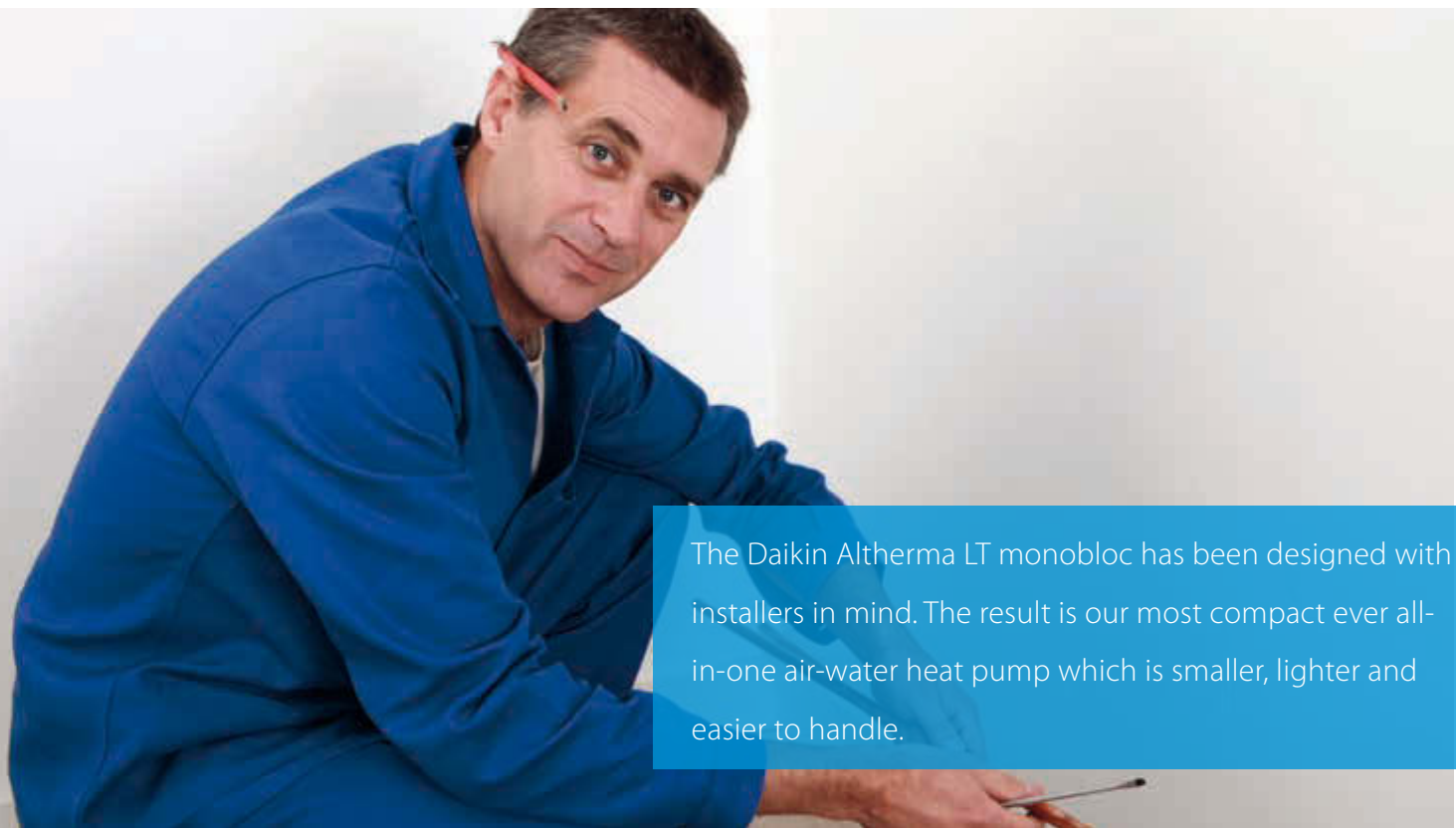

The Daikin Altherma LT monobloc has been designed with installers in mind. The result is our most compact ever all-in-one air-water heat pump which is smaller, lighter and easier to handle.

Space-saving design

The outdoor unit, wiring centre and optional back-up heater have a casing design with a white finish, making it ideal for domestic customers. The space-saving outdoor unit has the smallest installed volume in the market (h735 x w1085 x d360mm) and weighs

just 80 kg. This means that the Daikin Altherma LT monobloc will fit even more homes quickly and easily, taking up less space in the garden.



Small and practical outdoor and indoor units

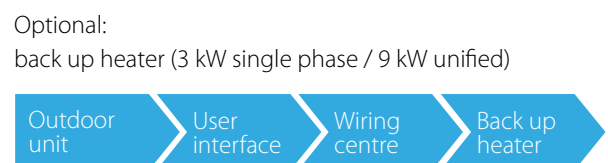
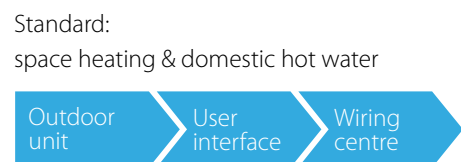
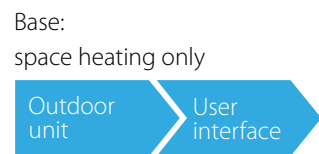
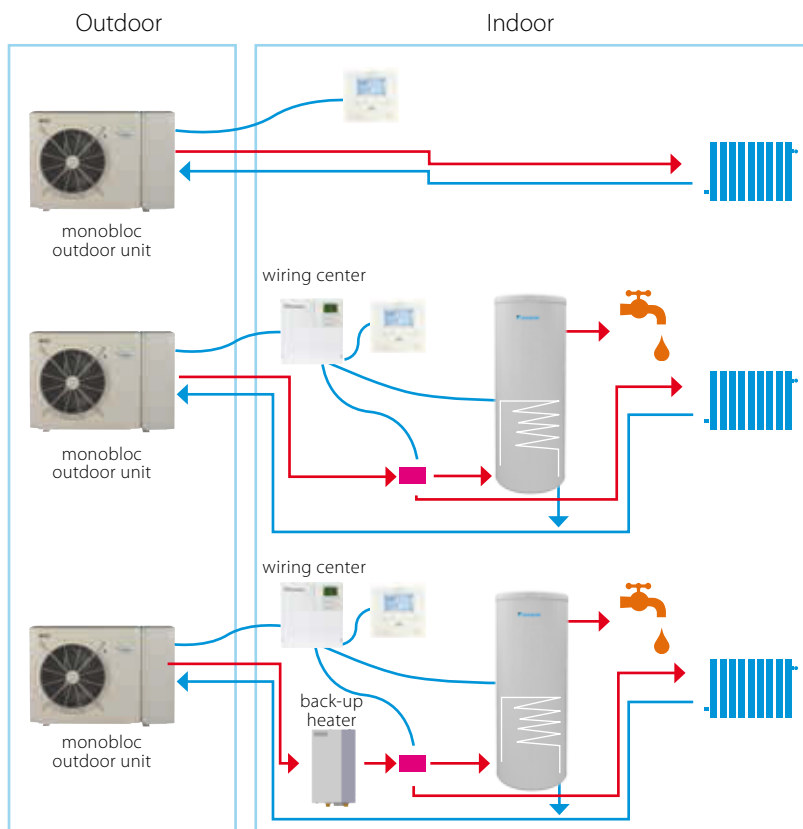

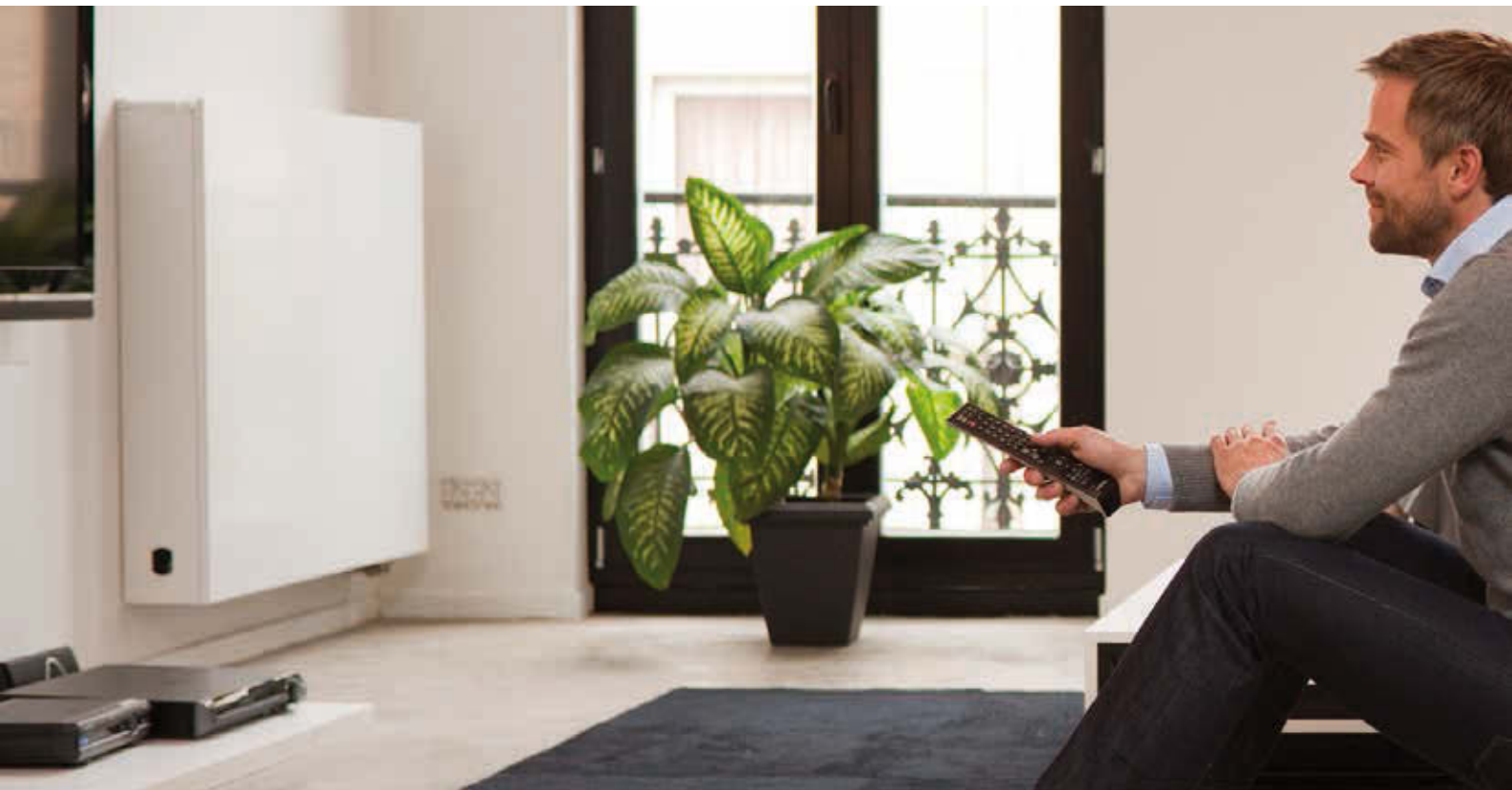

Fuss-free installation

The Daikin Altherma LT monobloc heat pump is easy to install. This is because it has a sealed refrigerant circuit so you do not need refrigerant handling or F-gas qualifications. It really does work straight out of the box with all the key hydraulic components in the

outdoor unit, reducing the risk of installation errors and eliminating the need for a separate expansion vessel, pump or isolation valves. So you can get projects completed with no unexpected hitches which maximises your profits on every job.

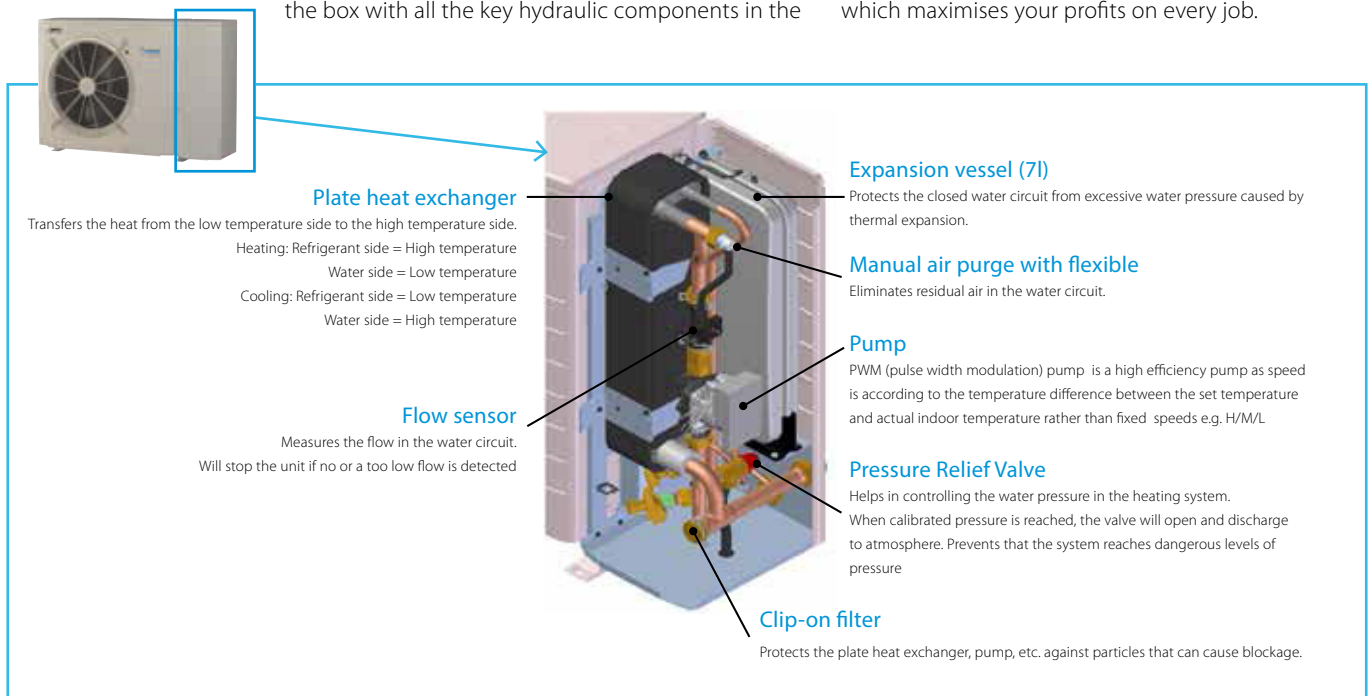

Market leading efficiencies

The Daikin Altherma LT monobloc is setting new standards of efficiency with high COPs in all conditions. Its new inverter compressor has a wide modulation range, which delivers lower minimum outputs at higher ambient temperatures.

So the system works at partial load for most of the year, reducing the load on the compressor, thus minimising running costs and maximising the system's lifespan.

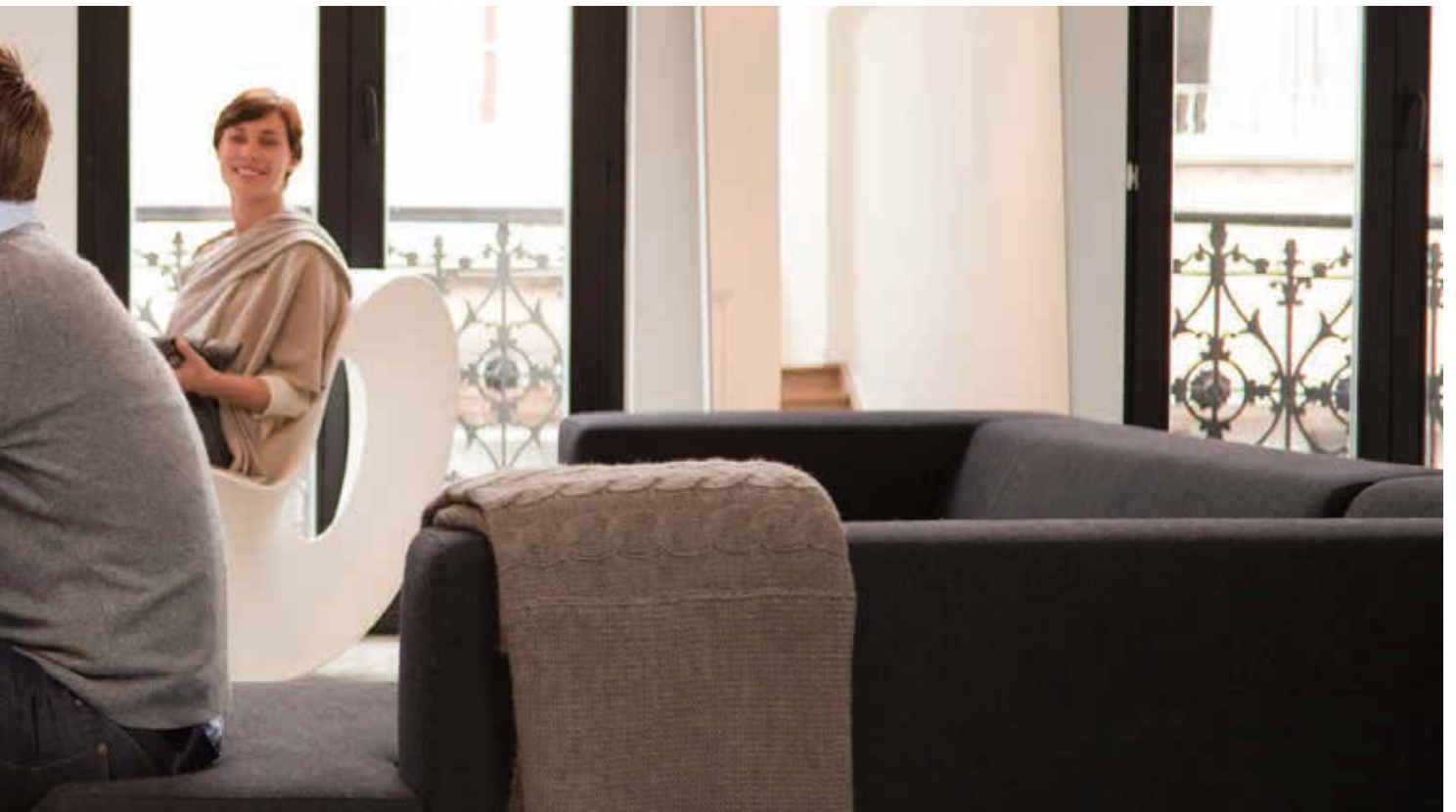

Reliable all year round

With flow temperatures of up to 55°C even during cold weather, the Daikin Altherma LT monobloc delivers higher heating capacity than any previous model at lower ambient temperatures (less than 10% drop off in heating capacity at -2°C). This makes it easier to select the right heat pump. A free hanging coil minimises frost build up, and reliable operation is guaranteed down to outdoor temperatures as low as -25°C. An optional back up heater is also available, for total customer peace of mind.

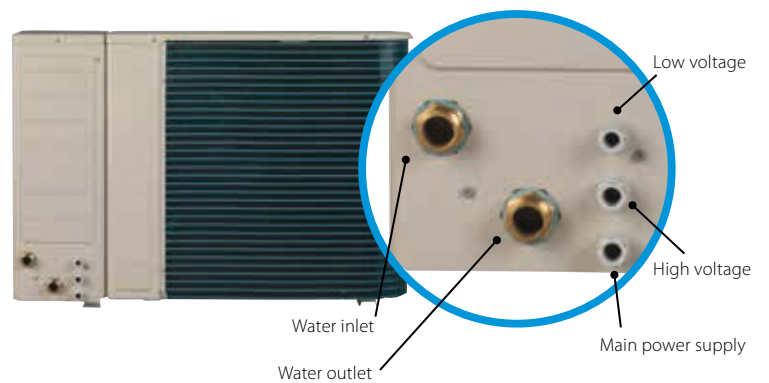

Complete control at your fingertips

The Daikin Altherma LT monobloc has a menu-driven user interface which can also be used as a programmable room thermostat. The backlit, plain text display makes it easier to commission, and the 'Quick wizard' guides you through the process. The settings can be uploaded via PC and heating/hot water schedules can be pre-set to minimise the risk of user error.

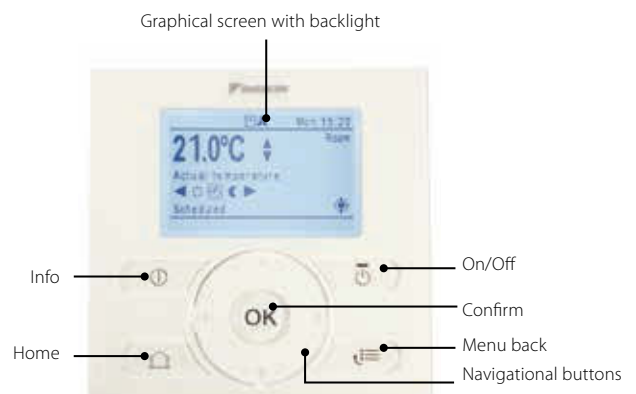

Everything you need from one source

The Daikin Altherma LT monobloc works efficiently with Daikin's range of underfloor heating, radiators and fan convectors. It can also be combined with solar thermal systems. So you can count on Daikin for your entire project.

EBLQ-CV3/EDLQ-CV3

Single Unit		EDLQ/EBLQ		05CV3		07CV3		05CV3		07CV3			
Heating capacity	Nom.	kW		4.40 / 4.03		7.00 / 6.90		4.40 / 4.03		7.00 / 6.90			
Cooling capacity	Nom.	kW		-		-		3.9 / 4.2		5.2 / 5.4			
Power input	Cooling	Nom.	kW		-		-		0.95 / 1.80		1.37 / 2.34		
	Heating	Nom.	kW		0.88 / 1.13		1.55 / 2.02		0.88 / 1.13		1.55 / 2.02		
COP				5.00 / 3.58		4.52 / 3.42		5.00 / 3.58		4.52 / 3.42			
EER				-		-		4.07 / 2.32		3.80 / 2.29			
Dimensions	Unit	Height	mm				735						
		Width	mm				1,085						
		Depth	mm				350						
Weight	Unit	kg		76		80		76		80			
Operation range	Heating	Water side	Min.~Max.	°C				15~55					
	Cooling	Ambient	Min.~Max.	°CDB		---				10~43			
		Water side	Min.~Max.	°C		---				5~22			
	Domestic hot water	Ambient	Min.~Max.	°CDB				-25~35					
Water side		Min.~Max.	°C				25~80						
Refrigerant	Type							R-410A					
	Charge	kg		1.30		1.45		1.30		1.45			
		TCO ₂ eq		2.7		3.0		2.7		3.0			
	Control							Expansion valve (electronic type)					
GWP								2,087.5					
Sound power level	Heating	Nom.	dBA		61		62		61		62		
	Cooling	Nom.	dBA				63						
Sound pressure level	Heating	Nom.	dBA		48		49		48		49		
	Cooling	Nom.	dBA		48		50		48		50		
Space heating	Average climate water outlet 55°C	General	^(p) Seasonal space heating efficiency	%		125		126		125		126	
			SCOP			3.20		3.22		3.20		3.22	
									A++				
	Average climate water outlet 35°C	General	^(p) Seasonal space heating efficiency	%		172		163		172		163	
SCOP					4.39		4.14		4.39		4.14		
										A++			

EKCB

Single Unit		EKCB/EK2CB		07CV3		2CB07CV3			
Dimensions	Unit	Height	mm				360		
		Width	mm				340		
		Depth	mm				97		
Weight	Unit	kg		4		-			
Operation range	Heating	Ambient	Min.~Max.		-		-		
	Indoor installation	Ambient	Min.	°CDB		5		-	
			Max.	°CDB		35		-	
Refrigerant	Charge	TCO ₂ eq		-		-			
	Control			-		-			
	GWP			-		-			

EKMBUHC3V3/EKMBUHC9W1

Single Unit		EKMBUHC3V3/ EKMBUHC9W1		3V3		9W1			
Dimensions	Unit	Height	mm				560		
		Width	mm				250		
		Depth	mm				210		
Weight	Unit	kg		11		13			
Operation range	Heating	Ambient	Min.~Max.		-		-		
	Indoor installation	Ambient	Min.	°CDB		5		-	
			Max.	°CDB		30		-	
Refrigerant	Charge	TCO ₂ eq		-		-			
	Control			-		-			
	GWP			-		-			

Trust Daikin

Daikin may not be a household name. After all, we don't make cars, TVs, fridges or washing machines. But we do make world-class heat pumps. In fact, more than 275,000 Daikin Altherma heat pumps have been fitted across Europe since its initial launch in 2006. Because we focus on doing only what we're best at: creating the most efficient heating, ventilation and air conditioning solutions, renowned for design excellence, quality and reliability. So your customers can depend on Daikin for the ultimate in comfort, leaving you free to focus on other essentials –like winning new work and growing your business.

Daikin Europe N.V.

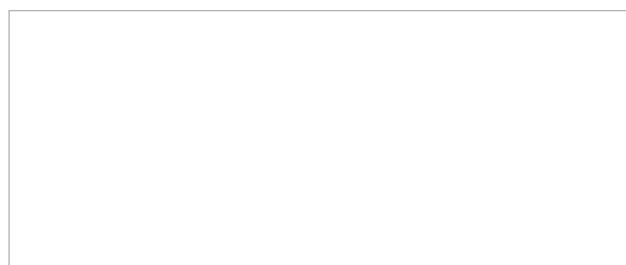

ECPEN15-727 XXX - 07/15



The present publication is drawn up by way of information only and does not constitute an offer binding upon Daikin Europe N.V. Daikin Europe N.V. has compiled the content of this publication to the best of its knowledge. No express or implied warranty is given for the completeness, accuracy, reliability or fitness for particular purpose of its content and the products and services presented therein. Specifications are subject to change without prior notice. Daikin Europe N.V. explicitly rejects any liability for any direct or indirect damage, in the broadest sense, arising from or related to the use and/or interpretation of this publication. All content is copyrighted by Daikin Europe N.V.

The present publication supersedes ECPEN14-727.
Printed on non-chlorinated paper.